

spruce

271 S. CASSINGHAM RD.
COLUMBUS, OH 43209
T (614) 300-0790

SETS & REVISIONS:	DATE
DESIGN OPTIONS	9-8-19
DESIGN REVISION OPTIONS	9-24-19
PREFERRED OPTION	10-30-19
FINAL	1-29-20

SOUTH COMMUNITY GARDEN

925 FERNDAL PL
BEXLEY, OH 43209

PROJECT NO: 1000

LOCATION PLAN

ALL DRAWINGS ARE THE ORIGINAL WORK OF SPRUCE AND MUST NOT BE REPRODUCED OR USED IN ANY MANNER WITHOUT THE WRITTEN CONSENT OF SPRUCE.

L-0

1 LOCATION PLAN
SCALE: 1" = 20' - 0"



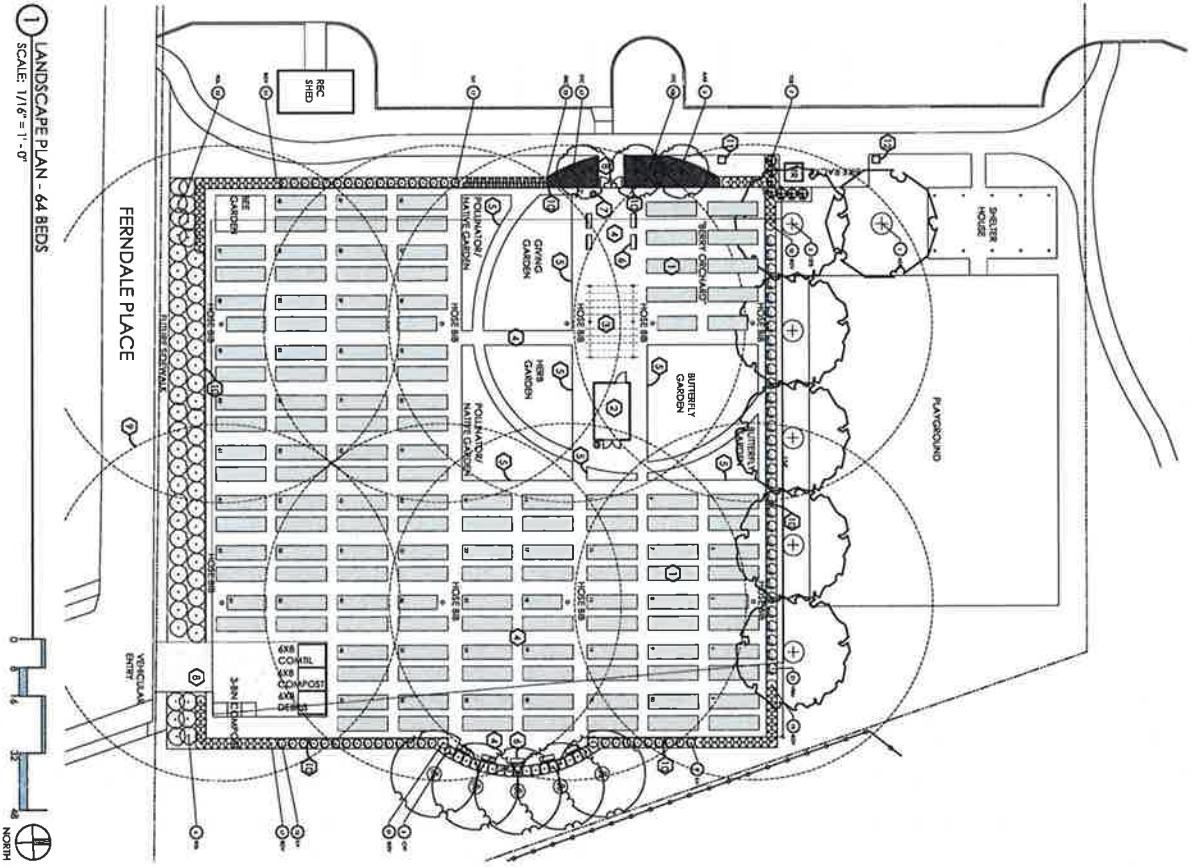

1 LANDSCAPE PLAN - 64 BEDS
SCALE: 1/16" = 1'-0"

PLANT LIST
CONTRACTOR RESPONSIBLE FOR ALL PLANTS SHOWN ON PLAN

QTY	KEY	BOTANICAL NAME	COMMON NAME	SIZE
1	ARB	ACER FRAXINIFOLIA	SMOOTH BAYBERRY	1"
2	ARB	AMELANCHIER ALBOVARIA	SPRINGBERRY	1.5"
3	CFP	CAREX CANADENSIS TORREYI PANSOT	HEBRID	2"
5	GIS	GEOMETRUM BRACHYCOMUM SCOTLAND	HIGHLAND HONNIT OCCULT	2"
SHRUBS				
23	BRC	BURDELLIA Y TILIA CHOP 2R	BLUE CHIP BUTTERFLY BUSH	4.5
88	BOV	BAYUS VIRENS VILVER	BOYWOOD	4.5
41	LN	IREA VIRGINICA TITILLI HENRY	WAXWING	4.5
24	NOE	TRILLIS ARIZONICA GROSSO CLAUD	WAXWING	4.5
31	VIA	VIBURNUM OBTUSIFOLIUM TILIA MURPHY	WAXWING	4.5
FERNS/ALGAE/ARTIFICIAL GRASSES				
11	FFC	ELDONYMUS SCOTLANDI COLORADOUS	WINTERCREEPER ELDERWOOD	4.5

CONSTRUCTION NOTES:

- 1 4X14 RAISED PLANK BED, TP.
- 2 10X16 PREFABRICATED SHED
- 3 1.5X20.5 PERGOLA ON CONCRETE PAD
- 4 GRAVEL PATH
- 5 PLANTING BED AT GRADE WITH BLACK METAL EDGING, TP.
- 6 BENCH, TP.
- 7 TRASH CAN, TP.
- 8 CONCRETE PAD
- 9 57" RADIUS FOR HOSE, TP.
- 10 3" TALL CEDAR SPLIT RAIL FENCE
- 11 FREE LITTLE PANTRY
- 12 FREE LITTLE LIBRARY



2 PREFABRICATED SHED AND PERGOLA FROM NORTH GARDENS
SCALE: NIS

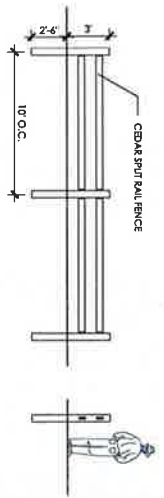

2 WOOD FENCE ELEVATION AND REPRESENTATIONAL IMAGE
SCALE: 1/8" = 1'-0"



271 S. CASSINGHAM RD.
COLUMBUS, OH 43207
1 (614) 300-0790

spruce

SOUTH COMMUNITY
GARDEN

925 FERNDALE PL
BEXLEY, OH 43207

L-1

PROJECT NO. 2008
LANDSCAPE PLAN
ALL DIMENSIONS ARE IN DECIMALS UNLESS OTHERWISE NOTED
CONTRACTOR RESPONSIBLE FOR ALL PLANTS SHOWN ON PLAN

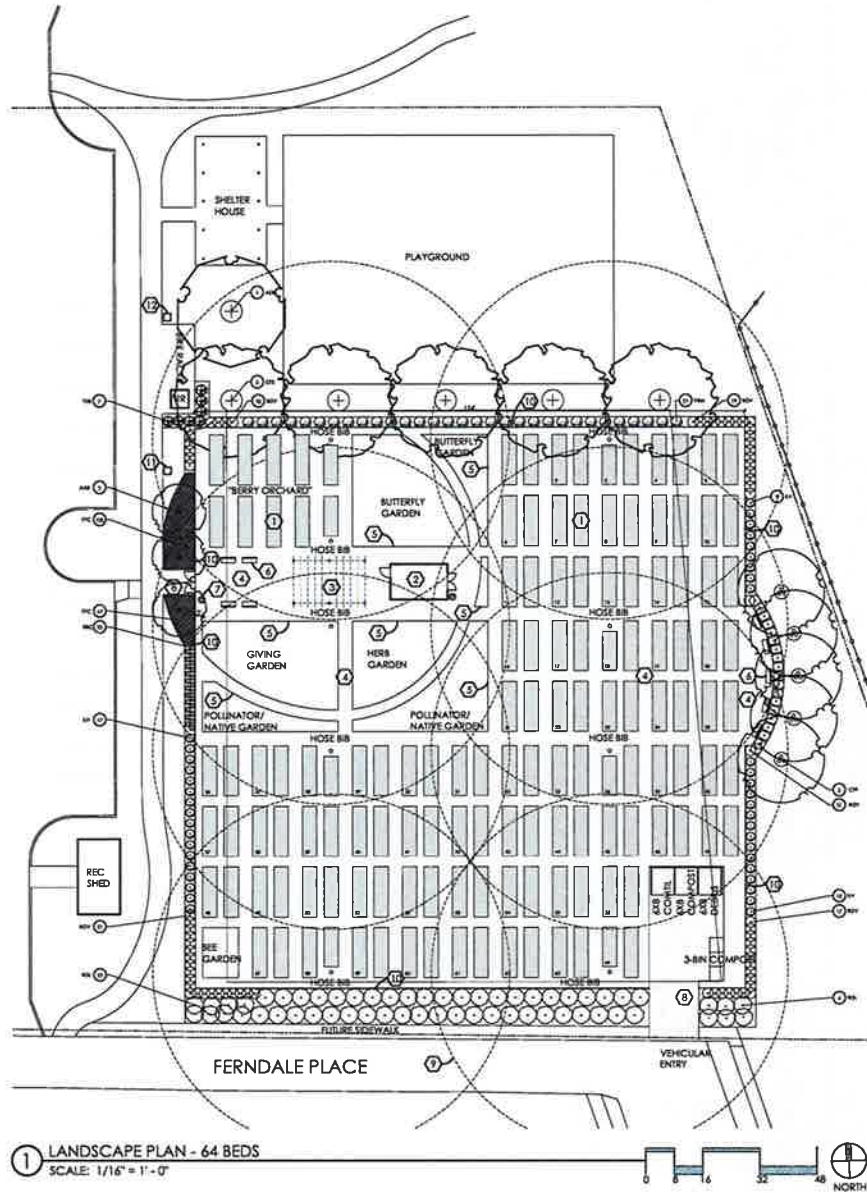

1 LANDSCAPE PLAN - 64 BEDS
SCALE: 1/16" = 1'-0"

PLANT LIST

(CONTRACTOR RESPONSIBLE FOR ALL PLANTS SHOWN ON PLAN)

QTY	KEY	BOTANICAL NAME	COMMON NAME	SIZE
TREES				
1	ASB	AESCULUS GLABRA	OHIO BUCKEYE	2"
3	AAH	AMELANCHIER X GRANDIFLORA 'AUTUMN BRILLIANCE'	SERVICEBERRY	1.5"
5	CFP	CERIS CANADENSIS 'FOREST PANSY'	REDBUD	2"
5	GS	GLEDITSIA TRACANTHOS 'SKYLINE'	THORNLESS HONEYLOCUST	2"
SHRUBS				
23	BBC	BUDDLEIA X 'BLUE CHIP JR'	BLUE CHIP BUTTERFLY BUSH	#3
88	BGV	BUXUS 'GREEN VELVET'	BOXWOOD	#3
41	ILH	ILEA VIRGINICA 'LITTLE HENRY'	VIRGINIA SWEETSPICE	#3
58	EGC	ERIGON AROMATICA 'GRACIOUS'	FRAGRANT SUMAC	#5
7	TOS	TRILLIA OCCIDENTALIS 'MARGARD'	EMERALD GREEN ARBORVITAE	6-7"
31	VBM	VIBURNUM DENTATUM 'BLUE MUFFIN'	VIBURNUM	#5
PERENNIALS/ORNAMENTAL GRASSES				
11	EFC	EUONYMUS FORTUNSI 'COLORATUS'	WINTERCREEPER EUONYMUS	#1

CONSTRUCTION NOTES:

- 1 4X14' RAISED PLANTER BED, TYP. TYPE: T8D
- 2 10X16' PREFABRICATED SHED
- 3 13.5X20.5' PERGOLA ON CONCRETE PAD
- 4 GRAVEL PATH
- 5 PLANTING BED AT GRADE WITH BLACK METAL EDGING, TYP.
- 6 BENCH, TYP.
- 7 TRASH CAN, TYP.
- 8 CONCRETE PAD
- 9 50' RADIUS FOR HOSE, TYP.
- 10 3' TALL CEDAR SPLIT RAIL FENCE
- 11 FREE LITTLE PANTRY
- 12 FREE LITTLE LIBRARY



2 PREFABRICATED SHED AND PERGOLA FROM NORTH GARDENS
SCALE: NTS

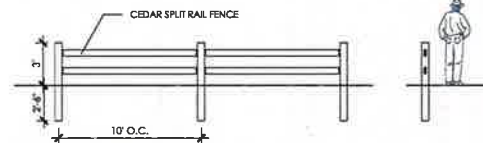

2 WOOD FENCE ELEVATION AND REPRESENTATIONAL IMAGE
SCALE: 1/4" = 1'-0"



spruce

271 S. CASSINGHAM RD.
COLUMBUS, OH 43209
T (614) 300-0790

SETS & REVISIONS:	DATE
DESIGN OPTION	9-8-19
DESIGN REVISION OPTIONS	9-24-19
PREFERRED OPTION	10-30-19
FINAL	1-29-20

SOUTH COMMUNITY GARDEN

925 FERDALE PL
BEXLEY, OH 43209

PROJECT NO: 0000

LANDSCAPE PLAN

ALL DRAWINGS ARE THE ORIGINAL WORK OF SPRUCE AND MAY NOT BE REPRODUCED, COPIED OR OTHERWISE USED IN ANY MANNER WITHOUT THE WRITTEN CONSENT OF SPRUCE.

L-1

PLANTS



ASCLEPIAS GLABRA
OHIO BUCKEYE



AMELANCHIER X GRANDIFLORA 'AUTUMN BRILLIANCE'
SERVICEBERRY



CERIS CANADENSIS 'FOREST PANSY'
REDBUD



GLEDITSIA TRIACANTHOS 'SKYLINE'
THORNLESS HONEYLOCUST



BUDDLEIA X BLUE CHIP JR.
BLUE CHIP BUTTERFLY BUSH



BUXUS 'GREEN VELVET'
BOXWOOD



TEA VISCAGNICA 'LITTLE HENRY'
VIRGINIA SWEETPIRE



RHUS AROMATICA 'GRO-LOW'
FRAGRANT SUMAC



THUJA OCCIDENTALIS 'SMARGADO'
EMERALD GREEN ARBORVITAE



VIBURNUM DENTATUM 'BLUE MUFFIN'
VIBURNUM



BIONYALIS FORTUNEI 'COLORATUS'
WINTERKREEPER BIONYALIS

spruce

271 S. CASSINGHAM RD.
COLUMBUS, OH 43209
T (614) 300-0790

DATE	BY	DESCRIPTION
10-20-19	ESALTY	GREEN PROPOSAL OPTIONS
10-30-19		PREFERRED OPTION
1-28-20		FINAL

SOUTH COMMUNITY GARDEN

925 FERNDALE PL
BEKLEY, OH 43209

PROJECT NO. 2008

IMAGES

ALL IMAGES ARE THE PROPERTY OF THE CLIENT AND SHALL REMAIN THE PROPERTY OF THE CLIENT. NO PART OF THIS DOCUMENT SHALL BE REPRODUCED OR TRANSMITTED IN ANY FORM OR BY ANY MEANS, ELECTRONIC OR MECHANICAL, INCLUDING PHOTOCOPYING, RECORDING, OR BY ANY INFORMATION STORAGE AND RETRIEVAL SYSTEM, WITHOUT THE WRITTEN PERMISSION OF THE CLIENT.

L-2

EXISTING PHOTOS



spruce

271 S. CASSINGHAM RD.
COLUMBUS, OH 43209
T (614) 300-0790

SEEL & REVISIONS:	DATE
DESIGN OPTIONS	8-11-17
DESIGN REVISION OPTIONS	8-11-17
REVISED OPTION	12-28-18
FINAL	

SOUTH COMMUNITY GARDEN

925 FERNDALE PL
BEXLEY, OH 43209

PROJECT NO: 3008

LANDSCAPE PLAN

ALL DIMENSIONS ARE IN DECIMAL FEET UNLESS OTHERWISE NOTED.
CONSTRUCTION SHALL BE IN ACCORDANCE WITH THE OHIO DEPARTMENT OF PUBLIC SAFETY CONSTRUCTION CODES.

L-1

PLANT LIST

(CONTRACTOR RESPONSIBLE FOR ALL PLANTS SHOWN ON PLAN)

QTY	SYMBOL	BOTANICAL NAME	COMMON NAME	SIZE
2	ASB	ASCLEPIAS GLABRA	OHIO BUCKLE	2"
3	AAB	AMELANCHIER X GRANDIFLORA 'AUTUMN BRILLIANCE'	SMOKY BUCKLE	1.5"
5	CFP	CERES CANADENSIS 'FOREST PANTRY'	RED BIRD	2"
5	GTS	GLEDITSIA TRIACANTHOS 'SYLVINE'	THORNLESS HONEYLOCUST	2"
SHRUBS				
23	BBC	BIDDULEIA X BLUE CHIP 'JK'	BLUE CHIP BUTTERFLY BUSH	#3
88	BBV	BIDENS GREEN VELVET	BONWOOD	#3
5	BG	BURNING BUSH	BURNING BUSH	#3
5	BS	BURNING BUSH	BURNING BUSH	#3
5	BS	BURNING BUSH	BURNING BUSH	#3
7	IDS	TRILLIS OCCIDENTALIS 'SWAGGARD'	EMERALD GREEN AKBORWITAE	6.7"
31	VBM	VIBURNUM ORIENTALIS 'BLUE MAJESTY'	VIBURNUM	6.5"
PERENNIAL/ORNAMENTAL GRASSES				
11	EFC	ELOONTIAE 'FORTUNE' 'COLOMBIUM'	WINTERCREEPER ELIANTHUS	#1

CONSTRUCTION NOTES:

- 4" X 4" RAISED PLANTER BED, TYP. TYPE 1B0
- 10' X 16' PREFABRICATED SHED
- 13.5' X 20.5' PERGOLA ON CONCRETE PAD
- GRAVEL PATH
- PLANTING BED AT GRADE WITH BLACK METAL EDGING, TYP.
- BENCH, TYP.
- TRASH CAN, TYP.
- CONCRETE PAD
- 50' RADIUS FOR HOSE, TYP.
- 3" TALL CEDAR SPLIT RAIL FENCE



2 PREFABRICATED SHED AND PERGOLA FROM NORTH GARDENS
SCALE: NTS

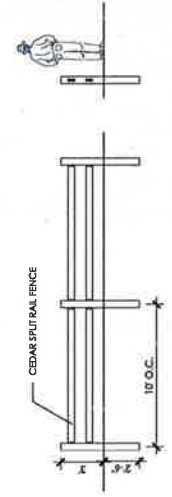

2 WOOD FENCE ELEVATION AND REPRESENTATIONAL IMAGE
SCALE: 1/4" = 1'-0"

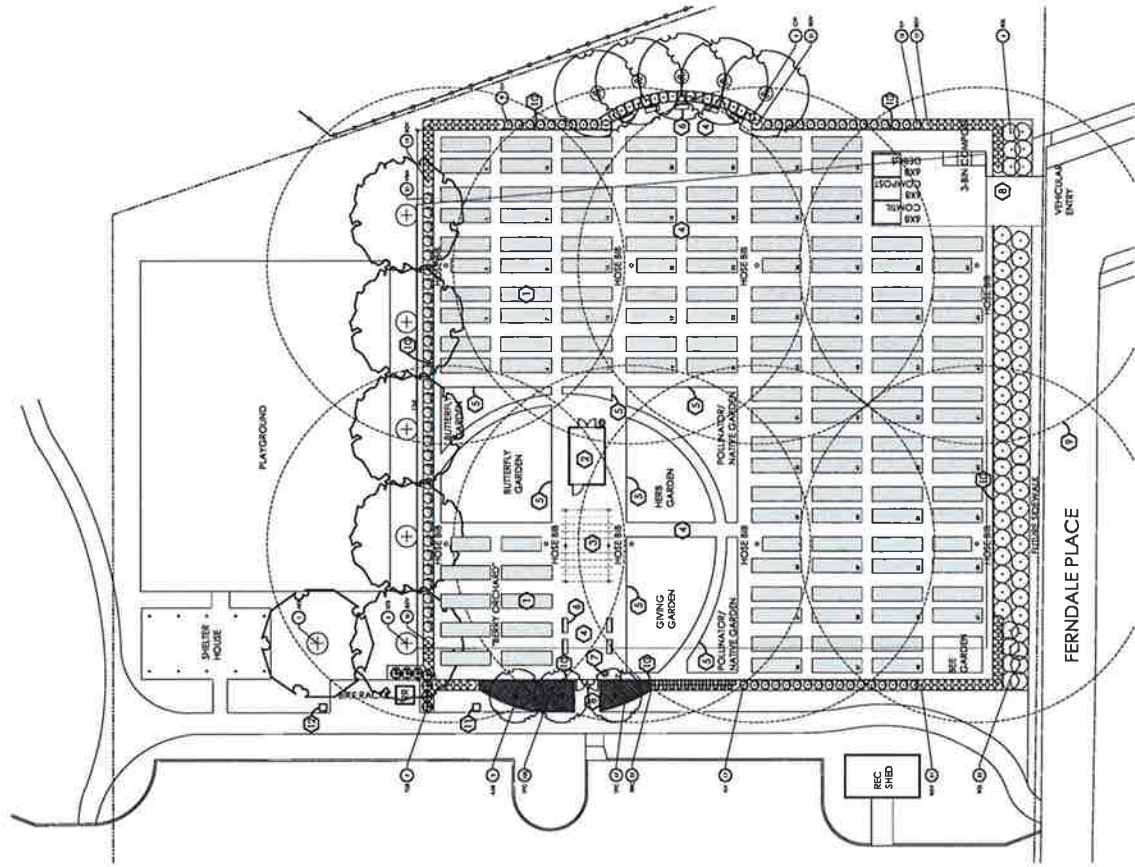

1 LANDSCAPE PLAN - 64 BEDS
SCALE: 1/16" = 1'-0"



spruce

271 S. CASSINGHAM RD.
COLUMBUS, OH 43207
T (614) 300-0790

REV. & REVISIONS:	DATE
DESIGN OPTIONS	04.19
CONCEPT OPTIONS	05.17
REVISED OPTION	05.27
FINAL	12.20

SOUTH COMMUNITY
GARDEN

925 FERNDALE PL
BEXLEY, OH 43209

PROJECT NO. 1006

HARDSCAPE PLAN

ALL DIMENSIONS ARE UNLESS OTHERWISE SPECIFIED AND SHALL BE CONSIDERED TO BE THE CENTER OF GRAVITY UNLESS OTHERWISE NOTED.

L-3

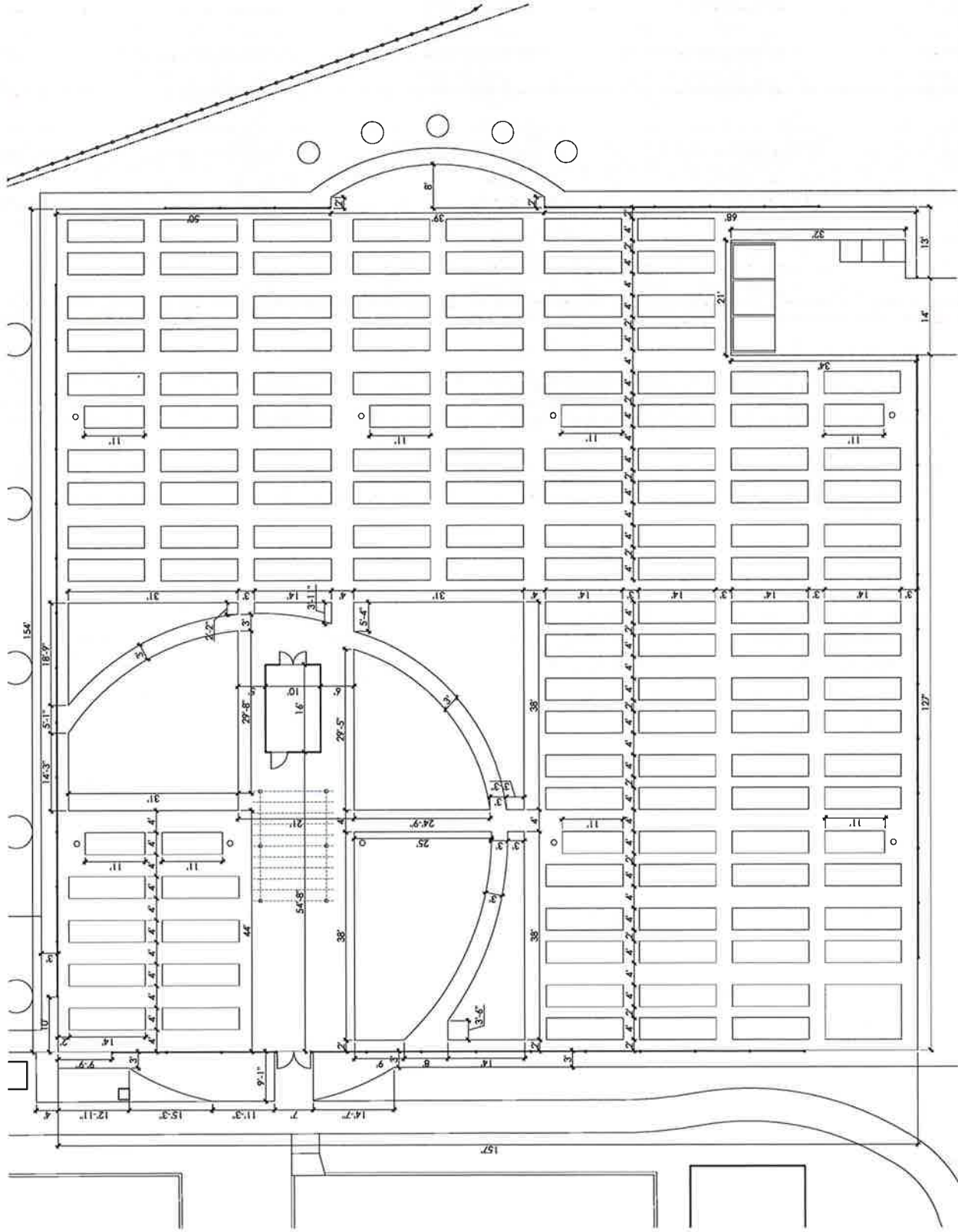

① HARDSCAPE PLAN
SCALE: 1/8" = 1'-0"

