

CURVED EAVE DOUBLE PITCH

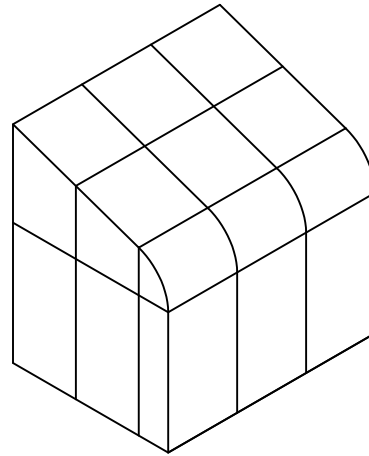

CURVED EAVE LEAN-TO

UNIT INFORMATION
GLAZING SET UP: Opening for $\frac{3}{8}$ " Monolithic Glazing to 1" Insulated Glazing, Polycarbonate, or Solid Panel Infill
Decorative interior and exterior low profile grid option.
Custom Configurations Available Upon Request
Designed and Manufactured in the U.S.A.

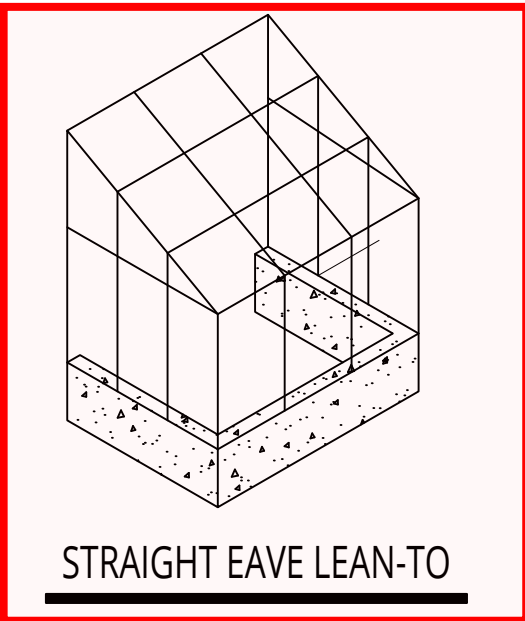

STRAIGHT EAVE LEAN-TO

ISOMETRIC ELEVATION
NOT TO SCALE

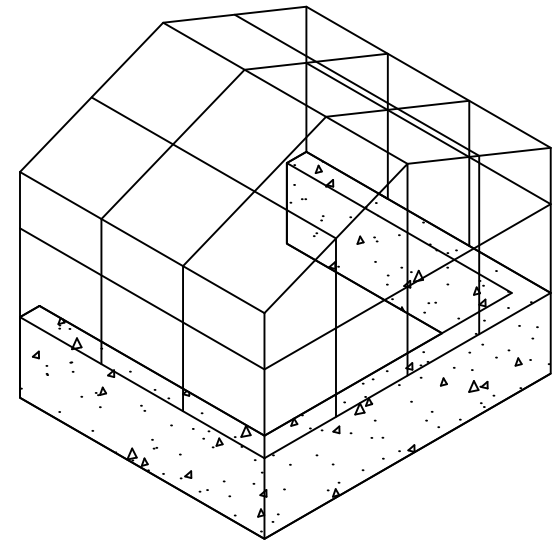

STRAIGHT EAVE DOUBLE PITCH

© 2017 Solar Innovations, Inc. - All Rights Reserved. These plans are the property of Solar Innovations, Inc. Any use or reproduction of these plans, in whole or in part, without the written permission of Solar Innovations, Inc. is forbidden.

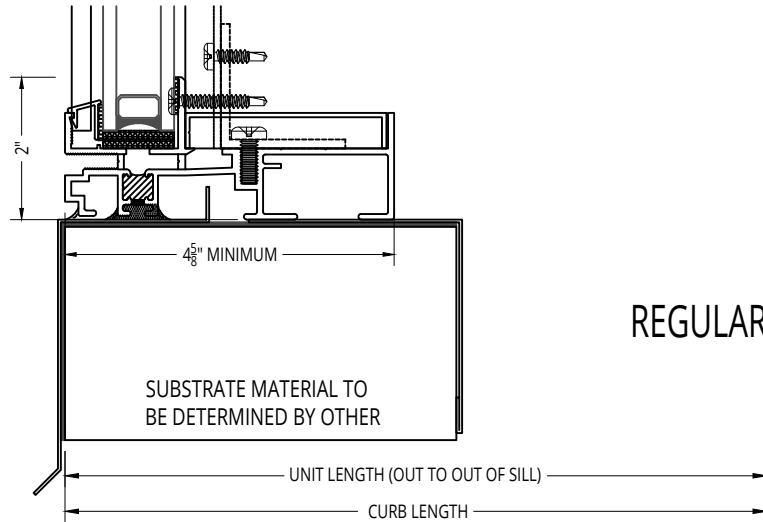

REGULAR INSULATED SILL

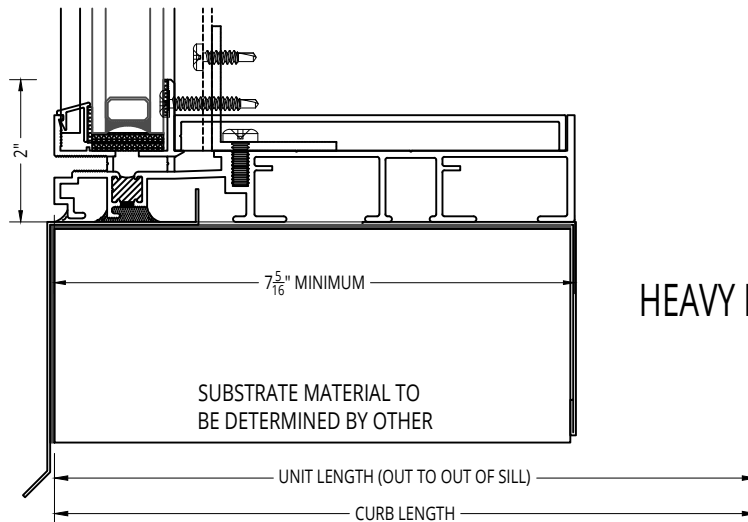

HEAVY INSULATED SILL

© 2017 Solar Innovations, Inc. - All Rights Reserved. These plans are the property of Solar Innovations, Inc. Any use or reproduction of these plans, in whole or in part, without the written permission of Solar Innovations, Inc. is forbidden.

2" SYSTEM RAFTERS

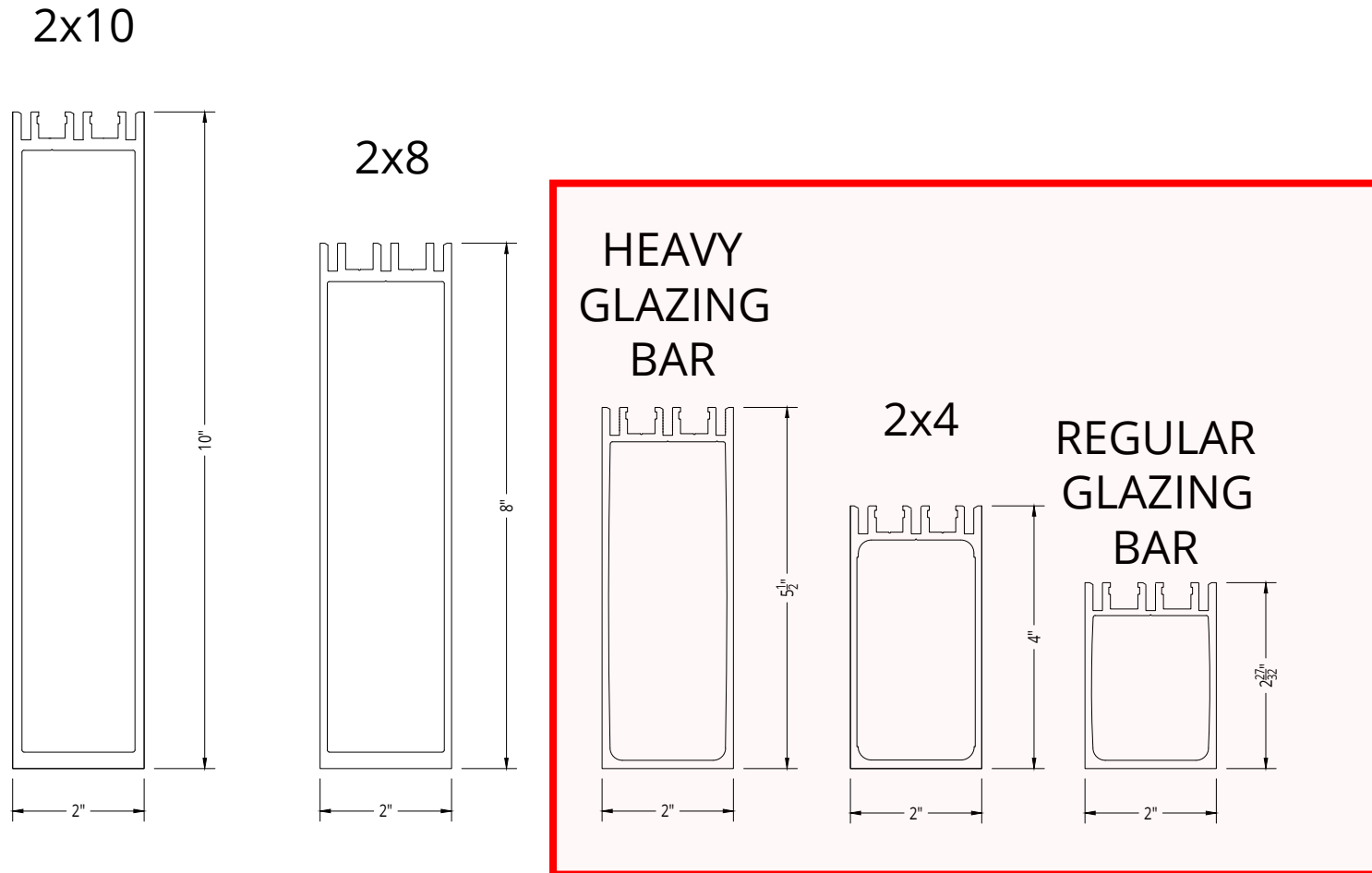

** Rafter Approval based on Final Engineering **

© 2017 Solar Innovations, Inc. - All Rights Reserved. These plans are the property of Solar Innovations, Inc. Any use or reproduction of these plans, in whole or in part, without the written permission of Solar Innovations, Inc. is forbidden.

2 1/2" SYSTEM RAFTERS

2 1/2" X 12

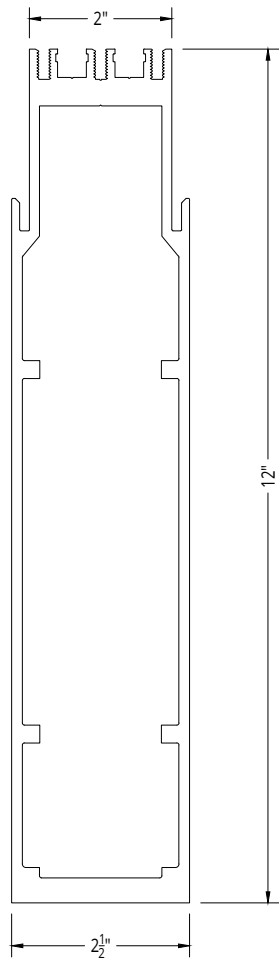

2 1/2" X 9 3/4

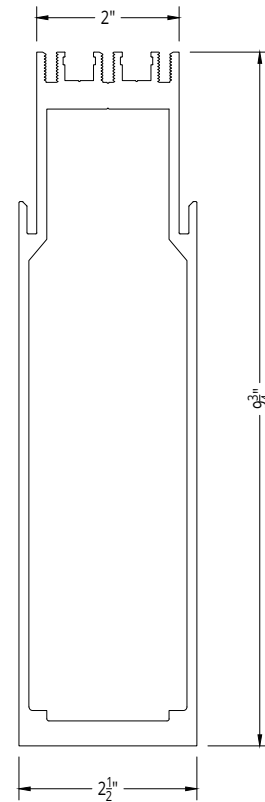

2 1/2" X 8

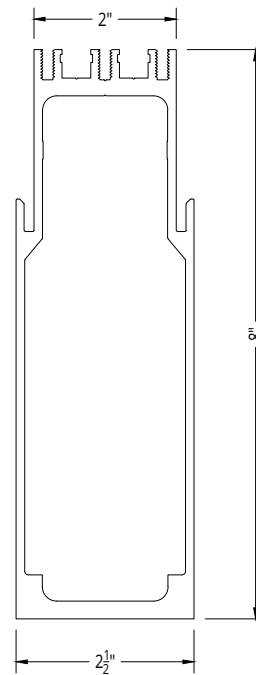

2 1/2" X 7

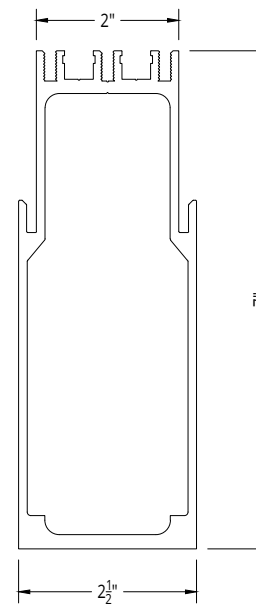

2 1/2" X 4

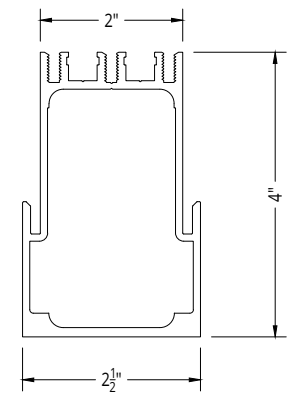

** Rafter Approval based on Final Engineering **

© 2017 Solar Innovations, Inc. - All Rights Reserved. These plans are the property of Solar Innovations, Inc. Any use or reproduction of these plans, in whole or in part, without the written permission of Solar Innovations, Inc. is forbidden.

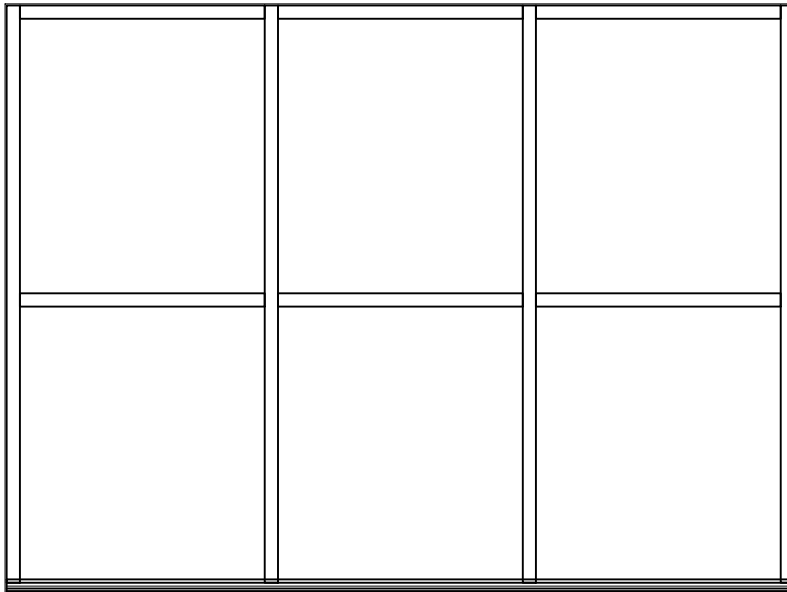

EXTERIOR ELEVATION

NOT TO SCALE

~ SOLAR INNOVATIONS' VERTICAL GLAZING SYSTEM ~

"INTERIOR"

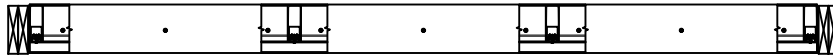

"EXTERIOR"

PLAN VIEW

NOT TO SCALE

UNIT INFORMATION

GLAZING SET UP: Opening for $\frac{3}{8}$ " Monolithic Glazing to 1" Insulated Glazing, Polycarbonate, or Solid Panel Infill

Decorative interior and exterior low profile grid option.

Custom Configurations Available Upon Request

Designed and Manufactured in the U.S.A.

© 2017 Solar Innovations, Inc. - All Rights Reserved. These plans are the property of Solar Innovations, Inc. Any use or reproduction of these plans, in whole or in part, without the written permission of Solar Innovations, Inc. is forbidden.

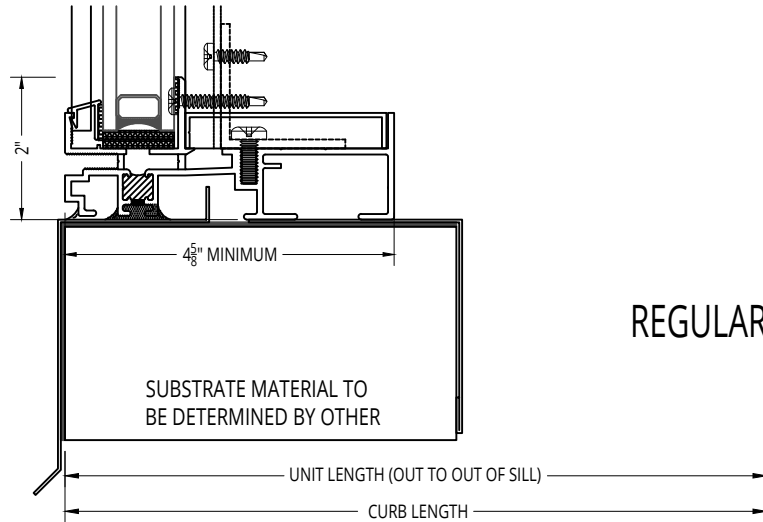

REGULAR INSULATED SILL

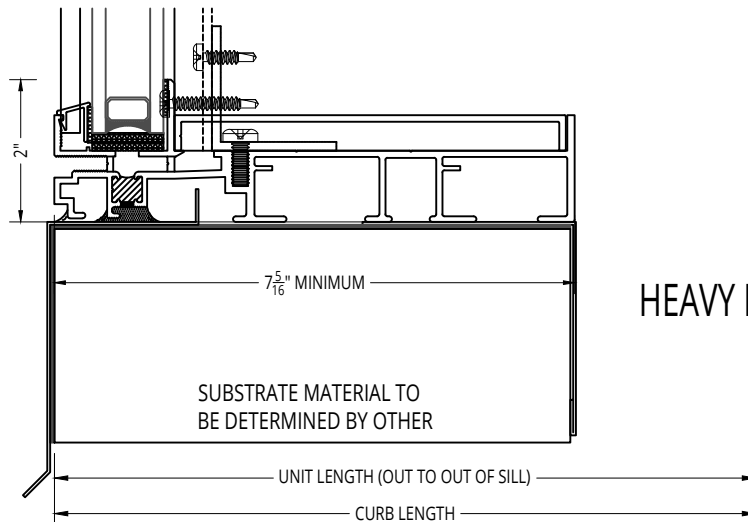

HEAVY INSULATED SILL

© 2017 Solar Innovations, Inc. - All Rights Reserved. These plans are the property of Solar Innovations, Inc. Any use or reproduction of these plans, in whole or in part, without the written permission of Solar Innovations, Inc. is forbidden.

2" SYSTEM RAFTERS

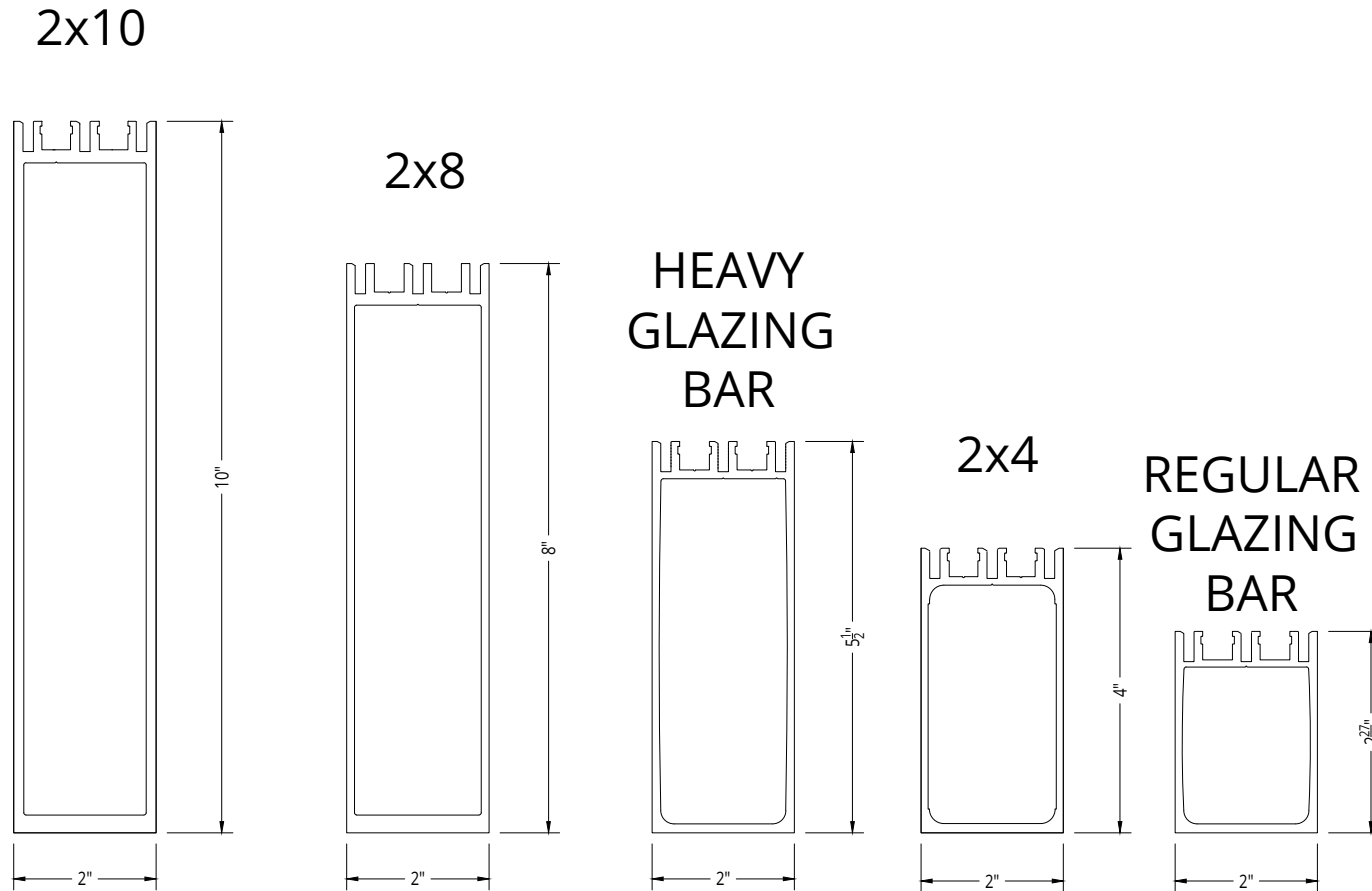

** Rafter Approval based on Final Engineering **

© 2017 Solar Innovations, Inc. - All Rights Reserved. These plans are the property of Solar Innovations, Inc. Any use or reproduction of these plans, in whole or in part, without the written permission of Solar Innovations, Inc. is forbidden.