

POST & BEAM LAYOUT

Handwritten signature

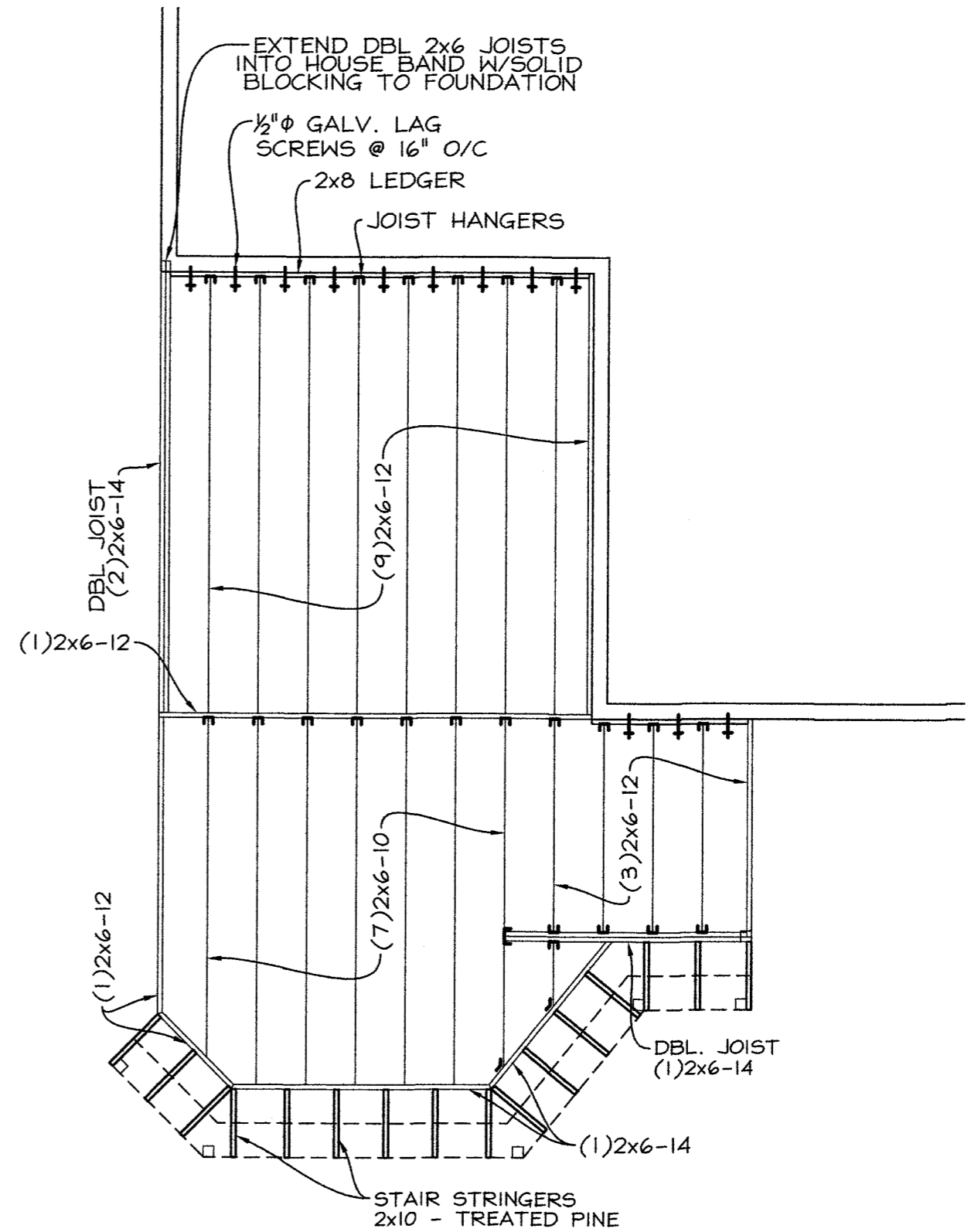

FLOOR JOIST LAYOUT

Handwritten signature

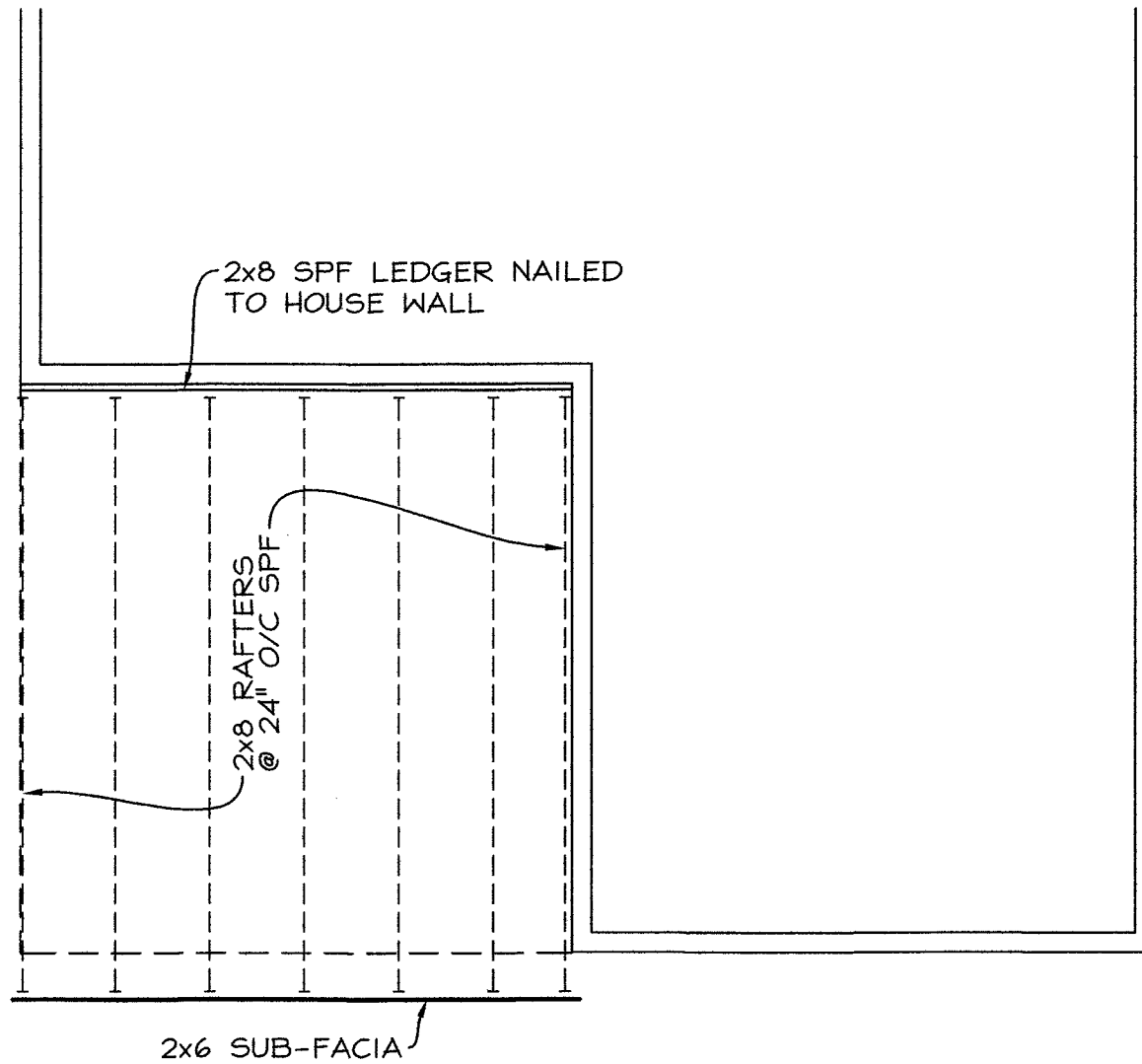

ROOF FRAMING LAYOUT

M

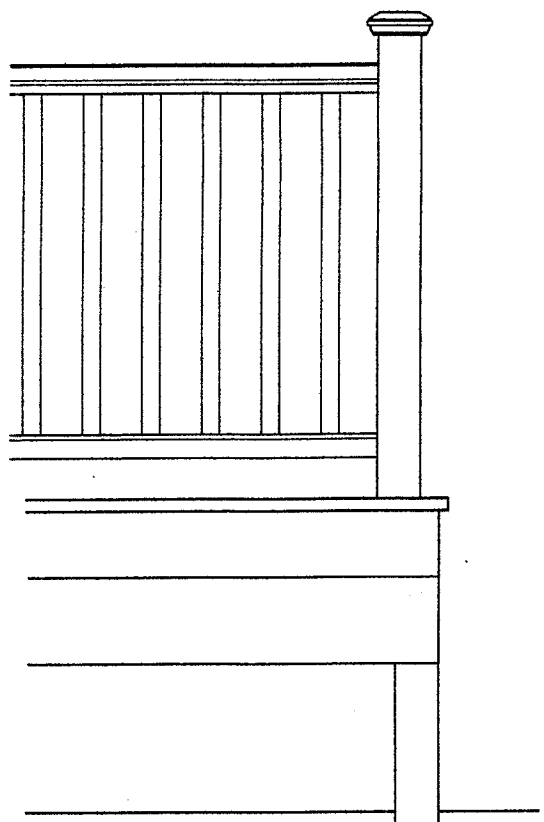

ELEVATION

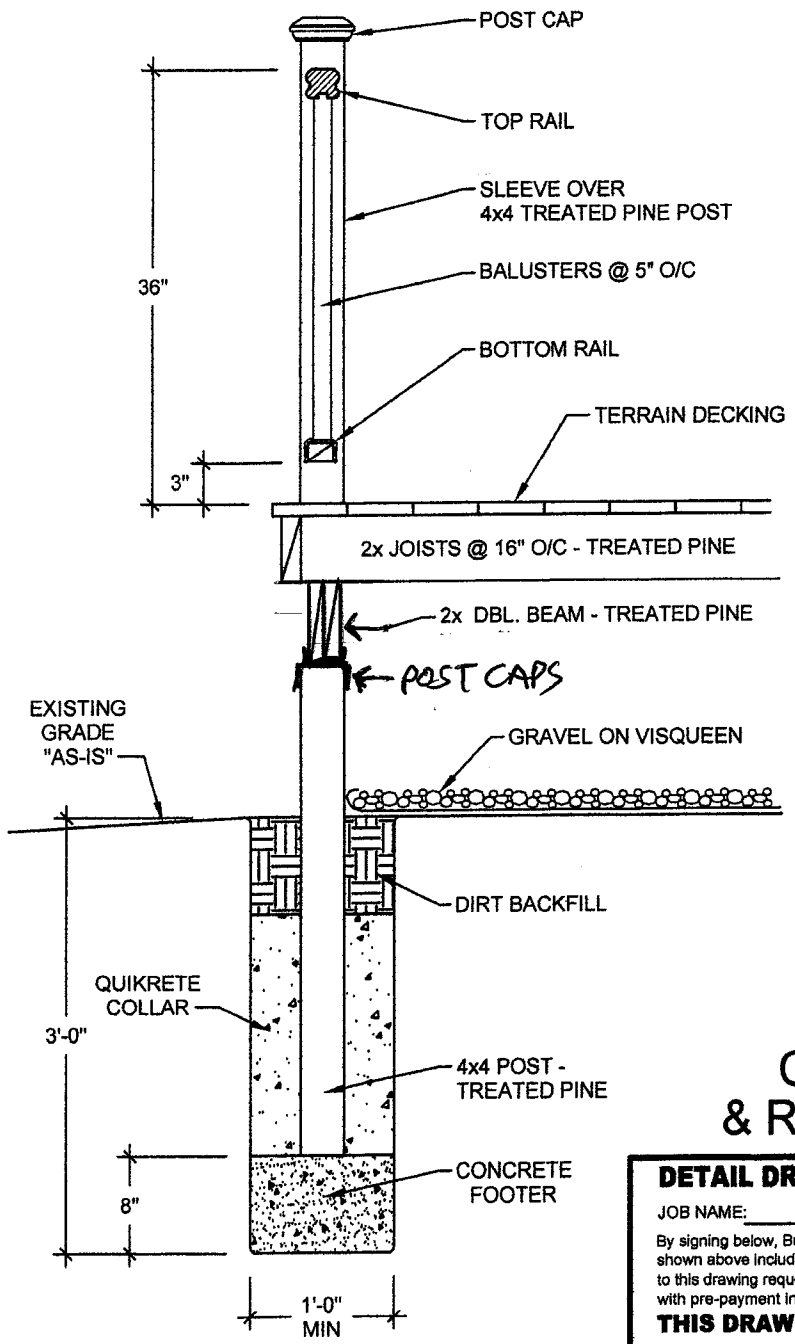

SECTION

RADIANCE EXPRESS RAILING:
 COLOR: _____

TIMBERTECH DECKING:
 STYLE: _____
 COLOR: _____

COMPOSITE DECK & RAILING DETAIL, TYP.

DETAIL DRAWING / SUNCRAFT CORPORATION, INC.®

JOB NAME: HUNTER JOB # 20050

By signing below, Buyer(s) acknowledge a complete understanding of the construction drawing shown above including measurements and materials specified. Any modifications or alterations to this drawing requested by Buyer(s) after approval must be on Suncraft® Change Order Form with pre-payment in full. No painting, staining, caulking, or nail hole filling included.

THIS DRAWING APPROVED BY:

x _____ Date: _____

x _____ Date: _____

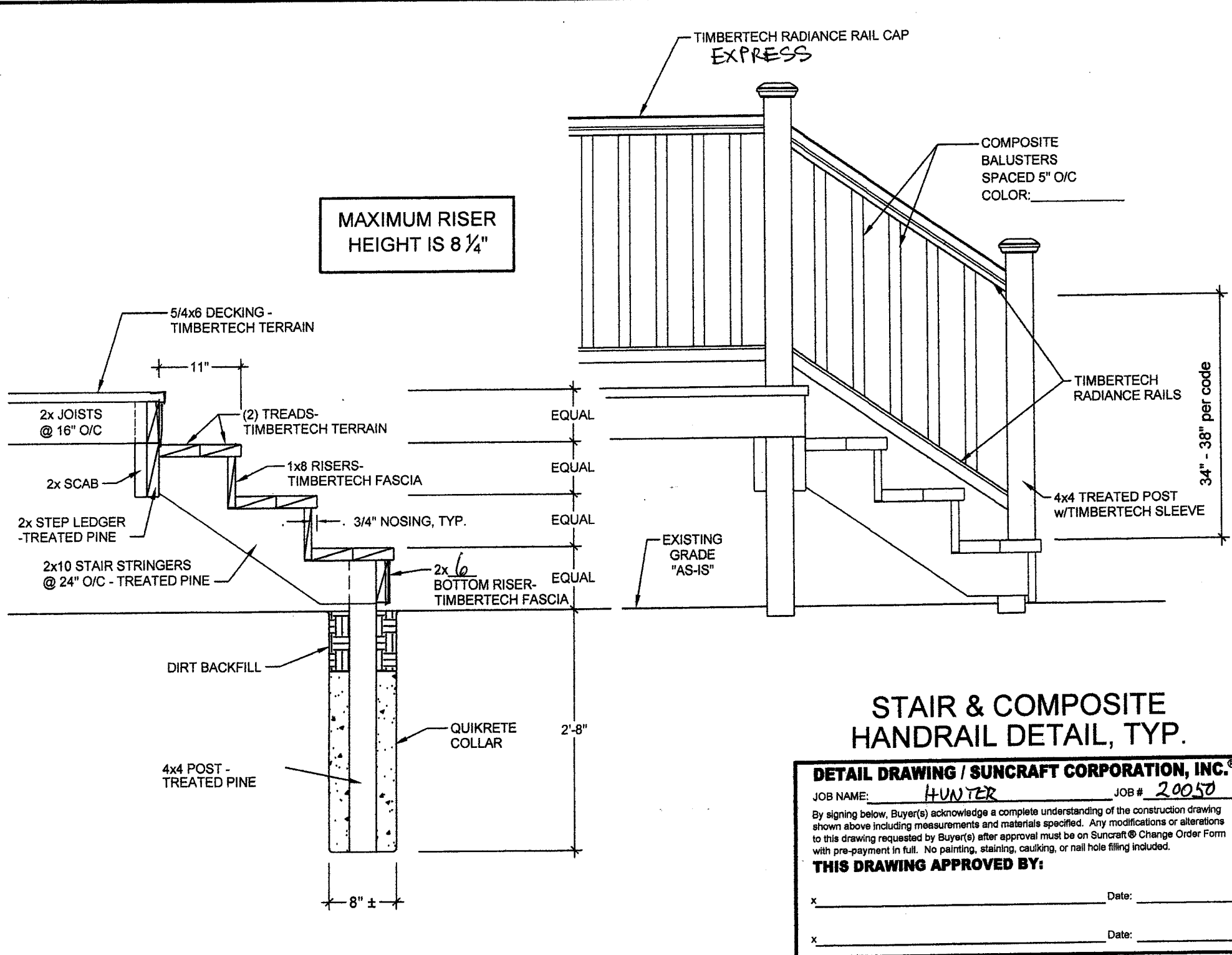

MAXIMUM RISER HEIGHT IS 8 1/4"

STAIR & COMPOSITE HANDRAIL DETAIL, TYP.

DETAIL DRAWING / SUNCRAFT CORPORATION, INC.®

JOB NAME: HUNTER JOB # 20050

By signing below, Buyer(s) acknowledge a complete understanding of the construction drawing shown above including measurements and materials specified. Any modifications or alterations to this drawing requested by Buyer(s) after approval must be on Suncraft® Change Order Form with pre-payment in full. No painting, staining, caulking, or nail hole filling included.

THIS DRAWING APPROVED BY:

x _____ Date: _____
 x _____ Date: _____

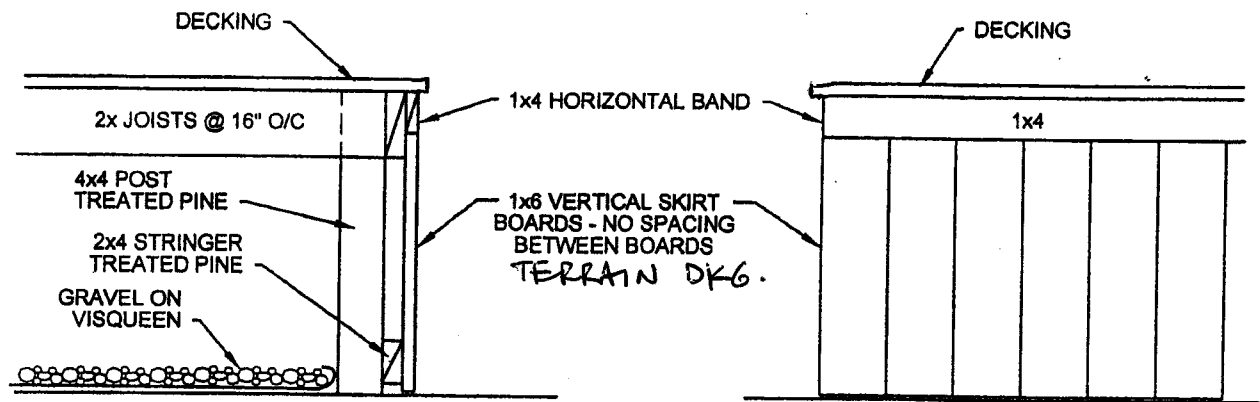

SECTION

ELEVATION

SKIRTING DETAIL, TYP.

DETAIL DRAWING / SUNCRAFT CORPORATION, INC.®

JOB NAME: HUNTER 20050 JOB # _____

By signing below, Buyer(s) acknowledge a complete understanding of the construction drawing shown above including measurements and materials specified. Any modifications or alterations to this drawing requested by Buyer(s) after approval must be on Suncraft® Change Order Form with pre-payment in full. No painting, staining, caulking, or nail hole filling included.

THIS DRAWING APPROVED BY:

X _____ Date: _____

X _____ Date: _____

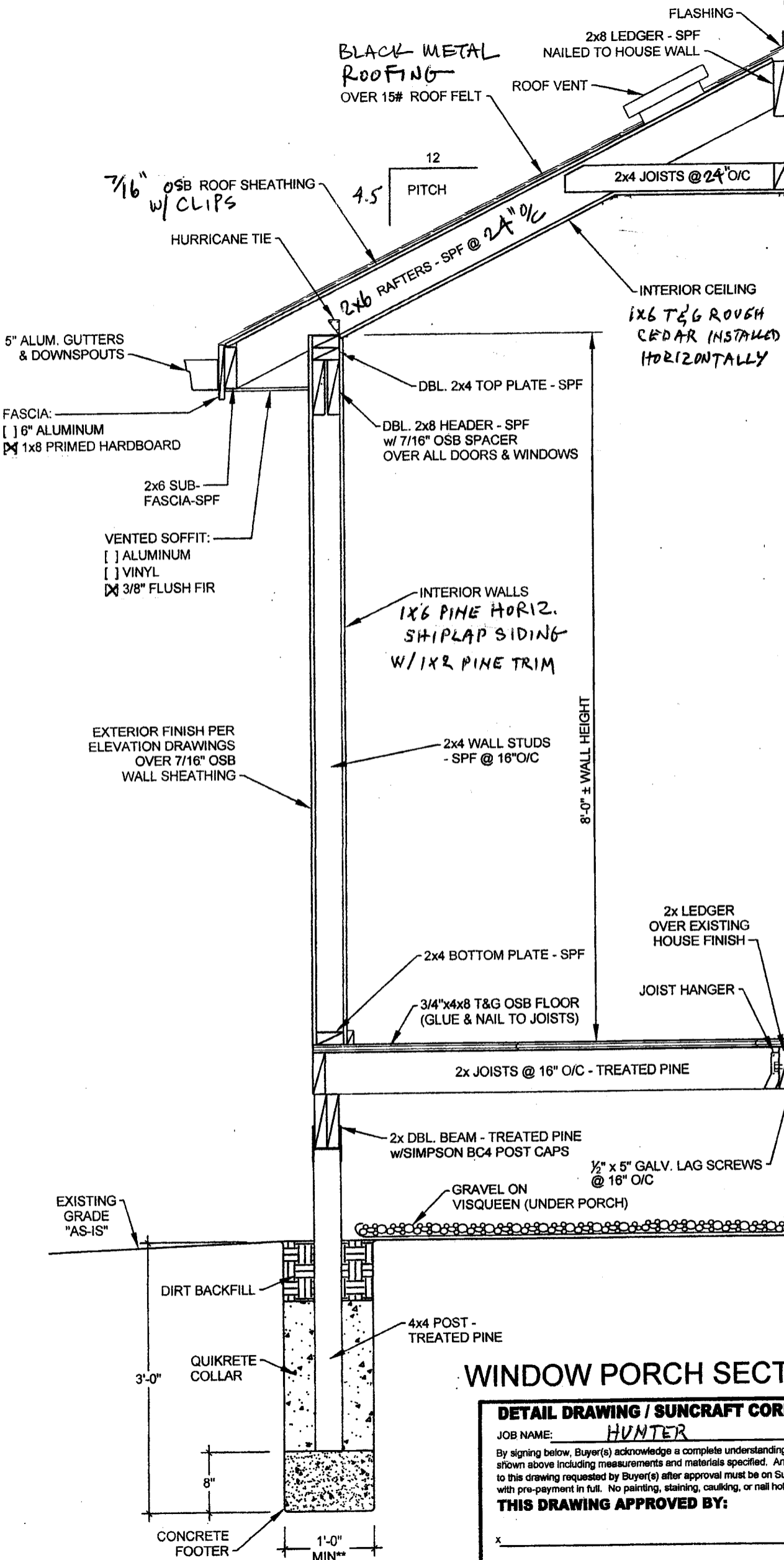

WINDOW PORCH SECTION, TYP.

DETAIL DRAWING / SUNCRAFT CORPORATION, INC.®

JOB NAME: HUNTER JOB # 200.50

By signing below, Buyer(s) acknowledge a complete understanding of the construction drawing shown above including measurements and materials specified. Any modifications or alterations to this drawing requested by Buyer(s) after approval must be on Suncraft® Change Order Form with pre-payment in full. No painting, staining, caulking, or nail hole filling included.

THIS DRAWING APPROVED BY:

x _____ Date: _____

x _____ Date: _____

SEE POST & BEAM LAYOUT DRAWING FOR EXACT SIZE

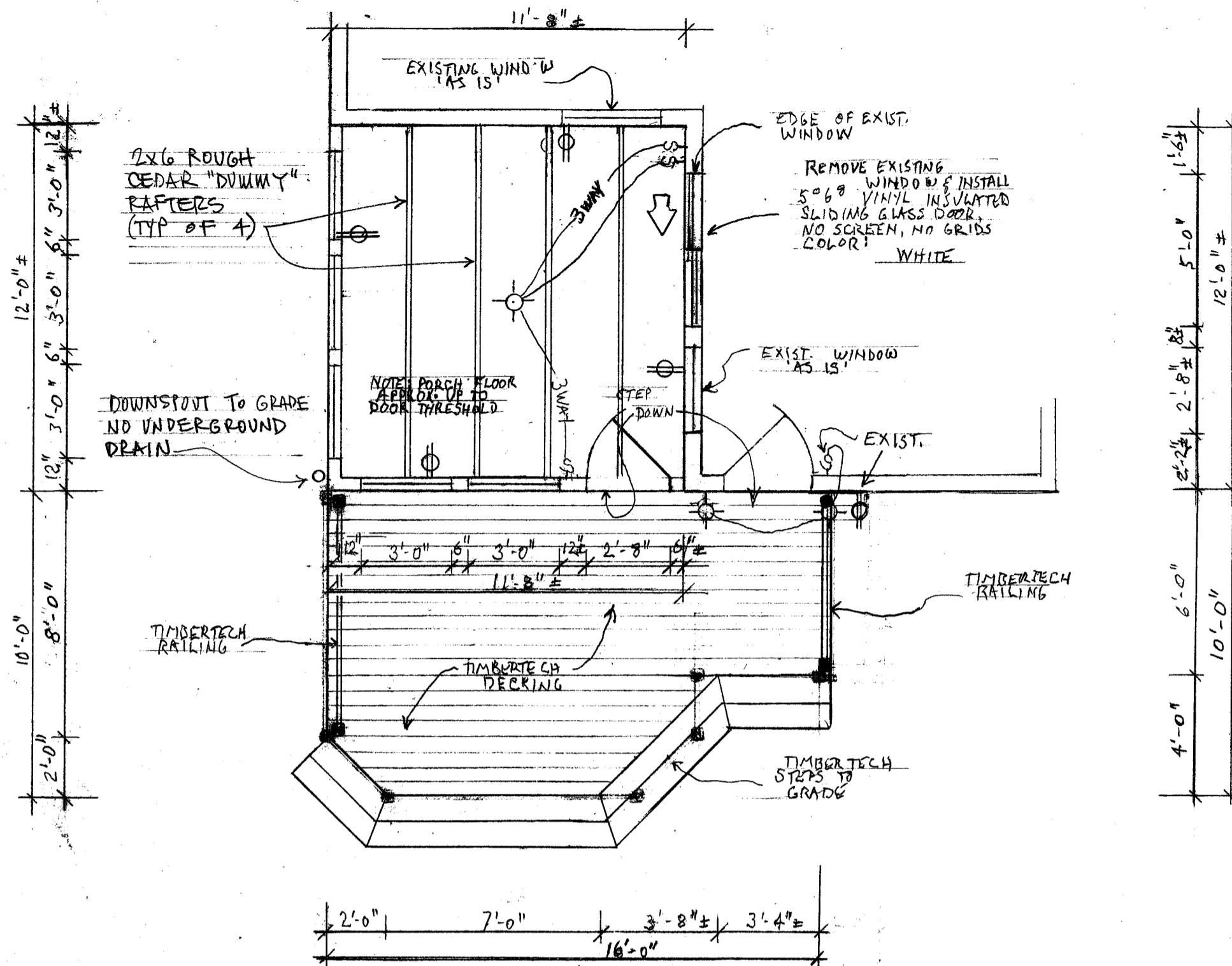

PLAN VIEW

NOTE: NO PAINTING, STAINING, CAULKING OR NAIL HOLE FILLING INCLUDED IN THIS PROJECT.

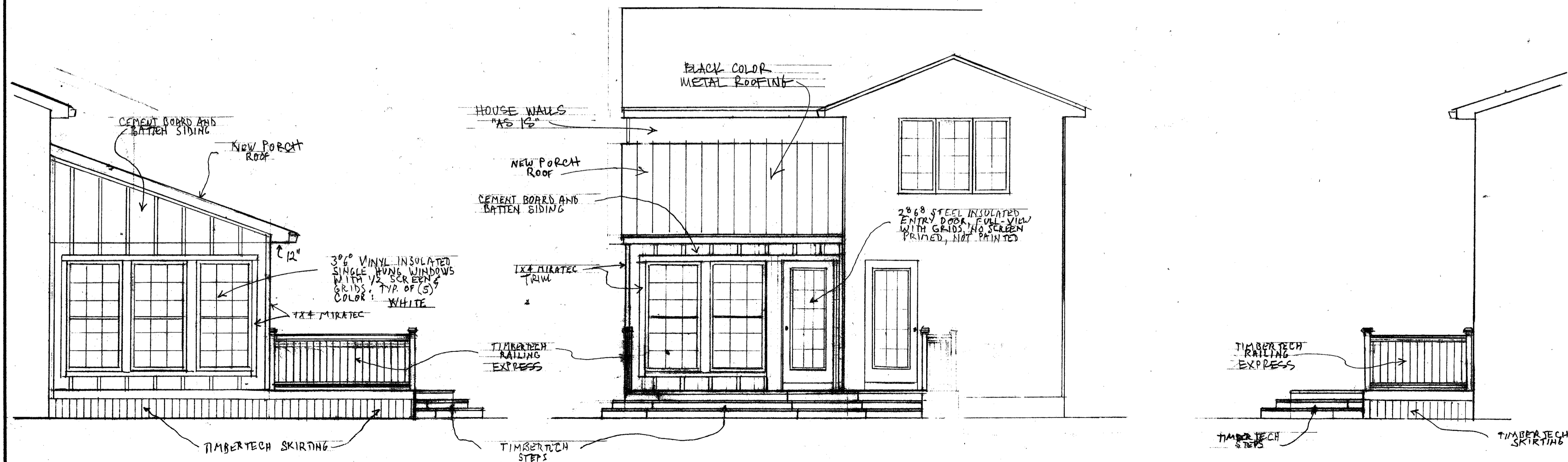

LEFT SIDE

ELEVATION

RIGHT SIDE

DESIGNER: *JK*
 SCALE: 1/4" = 1'-0"
 DATE: 14 APRIL 2005
 CHECKED: _____
 REVISED: _____
 APPROVED: _____ DATE: _____
 APPROVED: _____ DATE: _____

Suncraft Corporation, Inc. retains the common law copyright to the material appearing herein. The drawings are to be used only for the project and location specified herein. No other use, reproduction, or distribution is permitted without the written consent of Suncraft Corporation, Inc. All drawings are the property of Suncraft Corporation, Inc. and the same may not be copied, used or reproduced in any form without the written consent of Suncraft Corporation, Inc.

SUNCRAFT
 DESIGNED RIGHT. BUILT RIGHT.

Suncraft Corporation, Inc.
 122 West Johnstown Road
 Columbus, OH 43230
 Phone: (614) 475-0000
 Fax: (614) 475-0886

HUNTER SEAN & ANDREA
 730 EUCLAVILLE AVE. BEXLEY

PRELIMINARY
 PERMIT
 CONSTRUCTION

CONTRACT - PLAN # 20050 SHEET # /

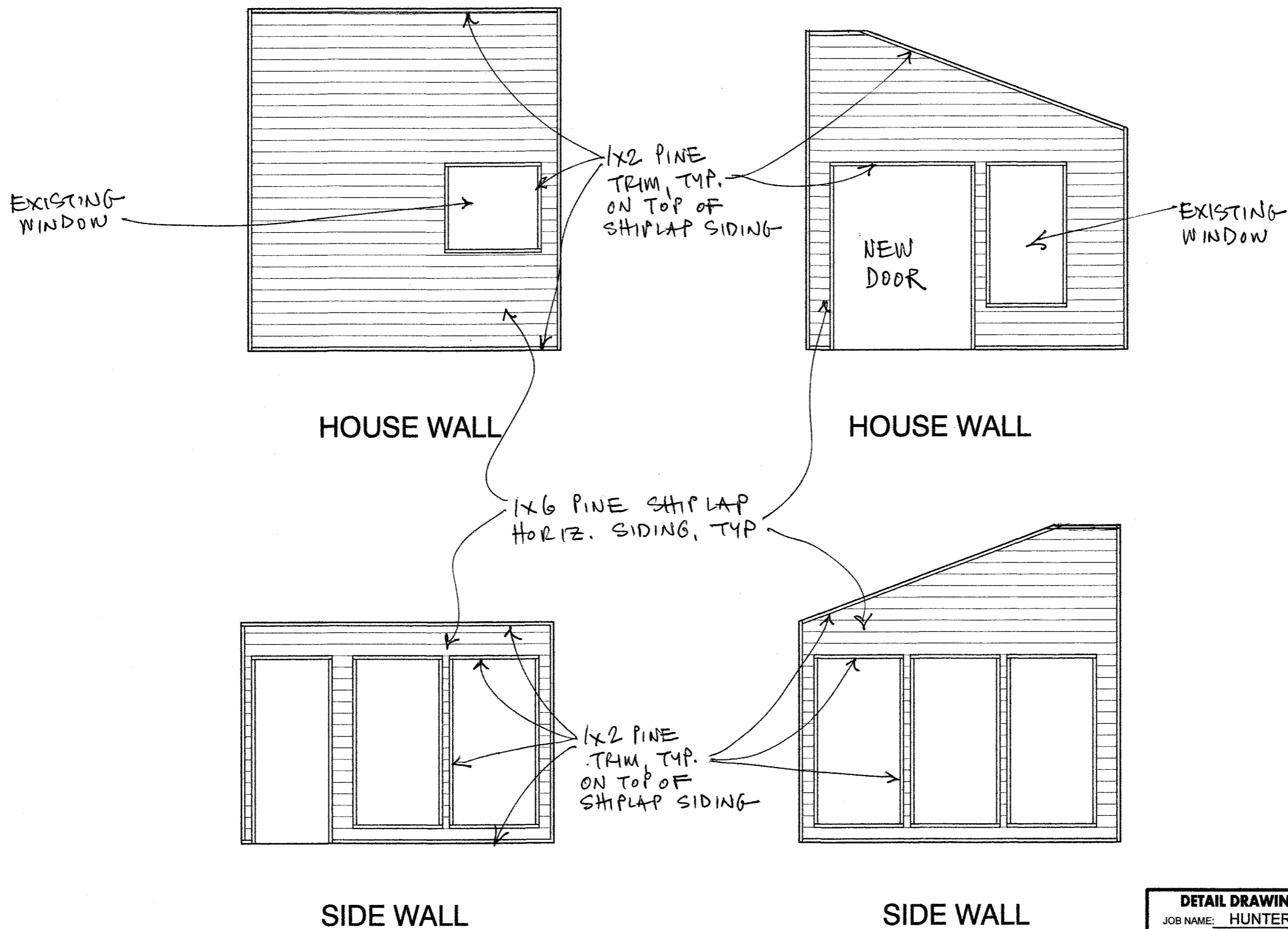

INTERIOR ELEVATIONS

DETAIL DRAWING / SUNCRAFT CORPORATION, INC.®

JOB NAME: HUNTER JOB # 20050

By signing below, Buyer(s) acknowledge a complete understanding of the construction drawing shown above including measurements and materials specified. Any modifications or alterations to this drawing requested by Buyer(s) after approval must be on Suncraft® Change Order Form with pre-payment in full. No painting, staining, caulking, or nail hole filling included.

THIS DRAWING APPROVED BY:

x _____ Date: _____

x _____ Date: _____